

# SUPER TUFF

## ///ATMODOOR®

APPROVED  
FOR USE IN  
REGISTERED  
ESTABLISHMENTS

AVAILABLE IN  
A LARGE  
SELECTION  
OF COLOURS

RESISTS  
DENTS,  
SCUFFS AND  
ABRASIONS



STANDARD  
1/2" THICK  
STRESS  
RELIEVED,  
HDP

ONE (1) PIECE,  
CONTINUOUS  
1/4" THICK  
EXTRUDED  
ALUMINUM FRAME.

FULLY  
ENCLOSED  
CAM  
TYPE HINGE

## SERIES 1500

### GENERAL PURPOSE RETAIL IMPACT DOOR

Designed for door openings up to 8'W X 8'H, Series 1500 General purpose Impact Doors offer the greatest usable door opening compared with similar doors. The Cam type hinge hardware is fully enclosed within a 1/4" thick anodized aluminum extrusion. The hidden hinge design minimizes door maintenance, maximizes door life and works well in wash down areas. Series 1500 doors are widely accepted in supermarkets, retail stores, restaurants, pharmacies, convenience stores and processing plants. This door is available in a large selection of colours and finishes to match or enhance interior design. The 1500 Series door can separate work or sales areas into public/private; climate controlled or noise areas. The visually appealing door improves customer and employee comfort and safety, and helps control energy costs.

**SUPER**  **SEAL**



**MODEL 1501**

Approved for use in registered establishments.

All doors noted rigid HDP impact traffic doors on the door schedule shall be Series 1500, Model 1501 as manufactured by Super Seal Mfg. Ltd.

Door Body shall consist of a 1/2" thick stress relieved, sanitized HDP sheet, colour \_\_\_\_\_. Panels shall be mounted in a one (1) piece, continuous 1/4" thick extruded aluminum frame with a satin anodized finish. Each panel shall have a clear safety acrylic window 9" wide x 14" high, set in a black rubber molding.

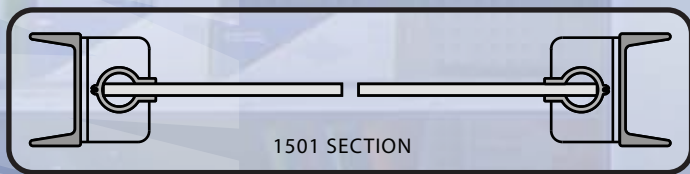

1501 SECTION

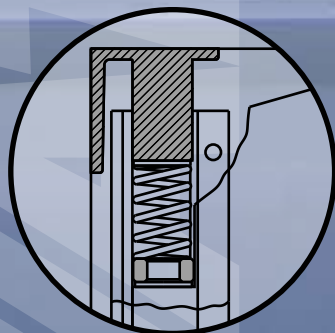

TOP HINGE DETAIL

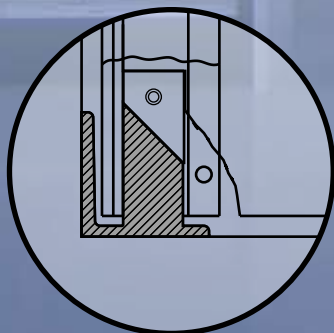

BOTTOM HINGE DETAIL



**MODEL 1502**

All doors noted rigid wood core impact traffic doors on the door schedule shall be Series 1500, Model 1502 as manufactured by Super Seal Mfg. Ltd.

Door Body Shall be 1/2" thick overall consisting of a one (1) piece structural grade plywood core clad with high pressure laminate sheets Brand \_\_\_\_\_, Colour \_\_\_\_\_, manufactures # \_\_\_\_\_; or with satin anodized aluminum face panels chemically bonded to both sides; or with full galvanized or stainless steel (please specify). The top and leading edge of each panel shall be finished with an 18-gauge stainless steel channel trim. Panels shall be mounted in a one (1) piece, continuous 1/4" thick extruded aluminum frame with a satin anodized finished. Each panel shall have a clear safety acrylic window 9" wide x 14" high, set in a black rubber molding.

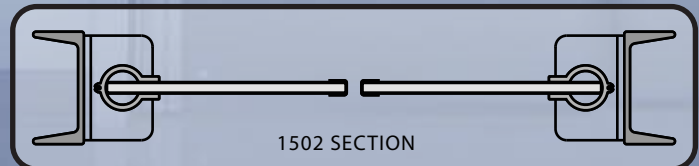

1502 SECTION

HINGE HARDWARE for models 1501, 1502, 1504 and 1505 shall be cast aluminum alloy floor and header mounted cam type hardware totally enclosed in a one (1) piece, continuous 1/4" thick extruded aluminum frame.



**MODEL 1504**

All doors noted rigid ABS impact traffic doors on the door schedule shall be Series 1500, Model 1504 as manufactured by Super Seal Mfg. Ltd.

Door Body shall consist of a 1/4" thick textured (1 side) ABS, colour \_\_\_\_\_. Panels shall be mounted in a one (1) piece, continuous 1/4" thick extruded aluminum frame with a satin anodized finish. Each panel shall have a clear safety acrylic window 9" wide x 14" high set in a black rubber molding.

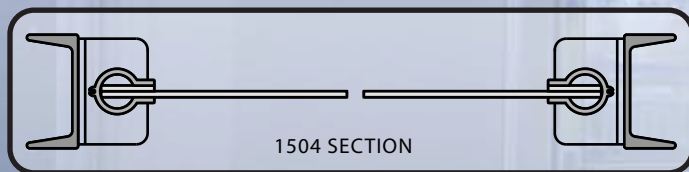

1504 SECTION



**MODEL 1505**

All doors noted rigid ABS fully gasketed impact traffic doors on the door schedule shall be Series 1500, Model 1505 as manufactured by Super Seal Mfg. Ltd.

Door Body shall consist of a chemically bonded 1/2" thick textured (both sides) ABS, colour \_\_\_\_\_. Panel shall be mounted in a one (1) piece, continuous 1/4" thick extruded aluminum frame with a satin anodized finish. Door panels have full perimeter gasketing installed in an integral channel. Each panel shall have a clear safety acrylic window 9" wide x 14" high, set in a black rubber molding.

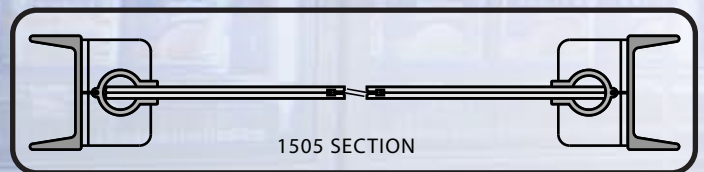

1505 SECTION

**THE COMPANY**

Super Seal Mfg. Ltd. Provides leadership, innovation and quality in the manufacturing of Impact Traffic Doors, automated fabric doors, stationary and inflatable dock seals and shelters, and accessories. A skilled and experienced sales, engineering and management team, coupled with professional craftspeople and state of the art production equipment ensures superior, long lasting products. Super Seal makes products for interior/exterior applications with a wide range of temperature and climate tolerance. Using the finest materials and leading technologies, SuperSeal products are design to increase durability, reliability, safety and at the same time decreasing energy and maintenance costs. Industries ranging from mining to manufacturing and from food distribution to pharmaceutical production have installed Super Seal products in facilities around the world. A trained dealer network is available to work with you and with Super Seal to provide a quality, custom product at an affordable price. Super Seal's after-sale support includes excellent warranties and superior customer service.

**OPTIONS**

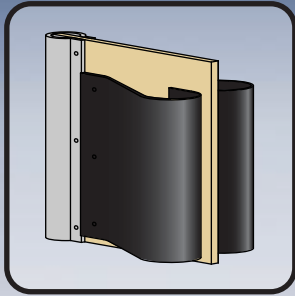

**A. Spring Bumpers**  
5/16" thick HDP  
black formed,  
up to 42" high available.

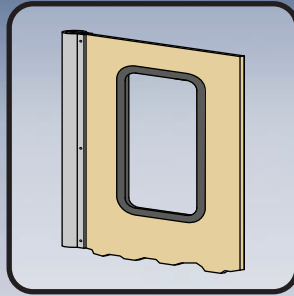

**B. Custom window**

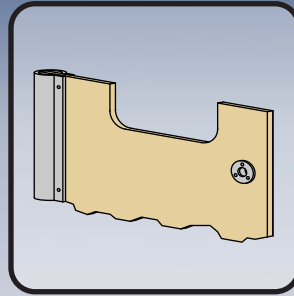

**C. Chain locking collar**

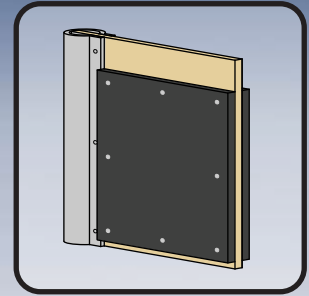

**D. Kick plates**  
1/4" thick ABS, 1/2" thick  
HDP, stainless or galvanized  
steel up to 48" high.

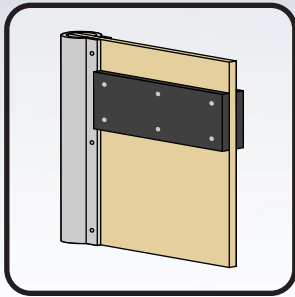

**E. Cart guard**  
1/2" thick  
x 4" high HDP.

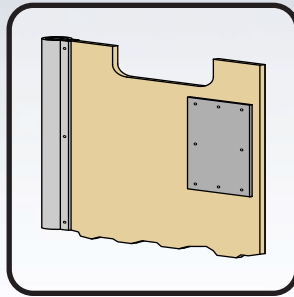

**F. Hand push plates**  
6" wide x 12" high  
stainless steel.

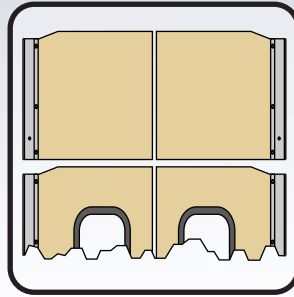

**G. Double Dutch**  
for added height.

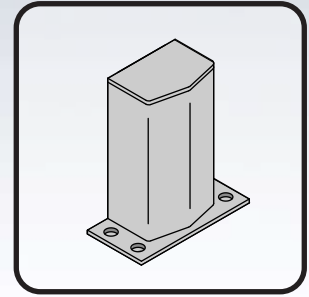

**H. Jamb guards**  
Floor mounted  
zinc plated, 9" high

**APPLICATIONS**

- Auto Stores
- Beer Stores
- Department Stores
- Drug Stores
- Flower Shops
- Liquor Stores
- Pet Stores
- Restaurants
- Super Centres
- Bakeries
- Delicatessen (Deli's)
- Distribution Centres
- Fish Markets
- Hospitals
- Manufacturing
- Receiving Area
- Retail Outlets
- Supermarkets

**COLOUR OPTIONS**

For colours other than those listed please consult manufacturer.

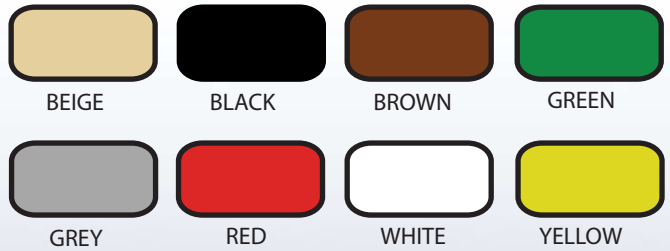

Colours may not be exactly as illustrated.

**TRAFFIC TYPES**



DEALER IMPRINT



\*\* All Super Seal products are subject to design modifications without notice. Product may be shown with non-standard options.